

# BRITE III Master Control Device

## Installation Manual

96A0428

Retain for future use.

Rev. D, 8/12/11



### Compliance with Standards

**FAA:** Approved for use with SMGCS systems. This includes both Stop Bar and Runway Guard Light control/monitoring according to AC 150/5340-30 (Current Edition); manufactured to AC 120-57 (Current Edition).

**ICAO:** Complies with CAT I/II/III ICAO lamp supervision requirements. Supports A-SMGCS for enhanced aircraft guidance in all weather conditions to prevent aircraft collisions and runway incursions.

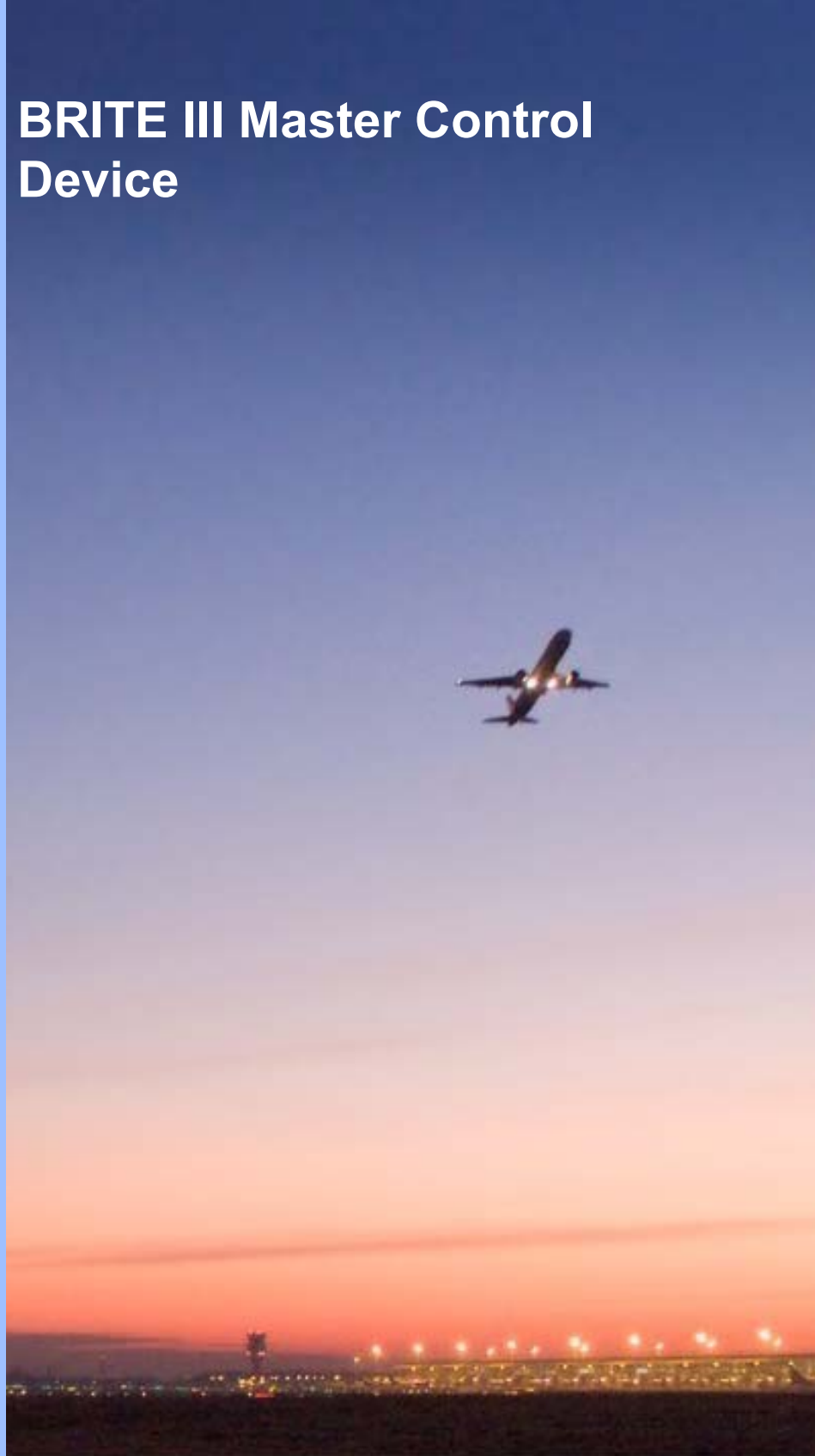

## Disclaimer

This manual could contain technical inaccuracies or typographical errors. ADB Airfield Solutions reserves the right to revise this manual from time to time in the contents thereof without obligation of ADB Airfield Solutions to notify any person of such revision or change.

Details and values given in this manual have been compiled with care. They are not binding, however, and ADB Airfield Solutions disclaims any liability for damages or detriments suffered as a result of reliance on the information given herein or the use of products, processes or equipment to which this manual refers. No warranty is made that the use of the information or of the products, processes or equipment to which this manual refers will not infringe any third party's patents or rights.

## Warranties

Products of ADB Airfield Solutions manufacturer are guaranteed against mechanical, electrical, and physical defects (excluding lamps) for a period of one year from the date of installation or a maximum of 18 months from date of shipment and are guaranteed to be merchantable and fit for the ordinary purposes for which such products are made.

ADB Airfield Solutions will correct by repair or replacement, at its option, equipment or parts which fail because of mechanical, electrical or physical defects, provided that the goods have been properly handled and stored prior to installation, properly installed and properly operated after installation, and provided further that Buyer gives ADB Airfield Solutions written notice of such defects after delivery of the goods to Buyer. Refer to the Safety section for more information on Material Handling Precautions and Storage precautions that must be followed.

ADB Airfield Solutions reserves the right to examine goods upon which a claim is made. Said goods must be presented in the same condition as when the defect therein was discovered. ADB Airfield Solutions further reserves the right to require the return of such goods to establish any claim.

ADB Airfield Solutions' obligation under this guarantee is limited to making repair or replacement within a reasonable time after receipt of such written notice and does not include any other costs such as the cost of removal of defective part, installation of repaired product, labor or consequential damages of any kind, the exclusive remedy being to require such new parts to be furnished.

ADB Airfield Solutions' liability under no circumstances will exceed the contract price of goods claimed to be defective. Any returns under this guarantee are to be on a transportation charges prepaid basis. For products not manufactured by, but sold by ADB Airfield Solutions, warranty is limited to that extended by the original manufacturer.

This is ADB Airfield Solutions' sole guarantee and warranty with respect to the goods; there are no express warranties or warranties of fitness for any particular purpose or any implied warranties of fitness for any particular purpose or any implied warranties other than those made expressly herein. All such warranties being expressly disclaimed.

## Trademarks

General notice: other product names used here are for identification purposes only and may be trademarks of their respective companies.

## Proprietary Information

This information carrier contains proprietary information, which shall not be used for other purposes than those for which it has been released, nor be reproduced or disclosed to third parties without the prior written consent of ADB Airfield Solutions.

No part of this publication may be reproduced, stored in a retrieval system, or transmitted in any form or by any means, mechanical, photocopy, recording, or otherwise, without the prior written permission of ADB Airfield Solutions. No patent liability is assumed with respect to the use of the information contained herein. Neither is any liability assumed for damages resulting from the use of the information contained herein.

ADB Airfield Solutions shall not be liable to the purchaser of this product or third parties for damages, losses, costs, or expenses incurred by purchaser or third parties as a result of accident, misuse, or abuse of this product or unauthorized modifications, repairs, or alterations to this product. ADB Airfield Solutions shall not be liable against any damages arising from the use of any options or parts other than those designated as approved products.

Copyright © 2010 by ADB Airfield Solutions. All rights reserved.

## a.0 Terms and Acronyms

General Aviation Terms and Acronyms that you may encounter using our manuals.

<b>ALCMS</b>	Acronym for Airfield Lighting Computer Monitoring System. An ALCMS incorporates many components that are used to control and monitor an airport's entire airfield lighting system. The ALCMS may include Touch Screens for lighting control, Maintenance Center(s) for data viewing and archiving, Electrical Lighting equipment for CCR control and monitoring.
<b>CCR</b>	Abbreviation for Constant Current Regulator. The CCRs are located within the Airfield Lighting Vault (ALV). They produce a constant current output to the airfield series circuit that light the airfield lighting fixtures.
<b>BRITE™</b>	ADB Airfield Solutions' trademarked abbreviation for Bi-directional Series Transceiver which is a term that describes the technology used to transmit and receive data across airfield lighting series circuit cabling.
<b>Remote</b>	Unit installed in the airfield (normally in pull-pits or base cans) which provides control and monitoring of individual or blocks of light fixtures. Each Remote has its own unique address for control and monitoring data communication to the Master.
<b>Master</b>	Unit installed within the lighting vault that provides the means for data communication on the airfield series circuit cables. The Master is connected in parallel (across) to the output of the CCR. Each series circuit that contains Remotes must also have a Master installed at the CCR.
<b>MWD</b>	Abbreviation of Microwave Detector. Microwave detectors are installed in pre-designated locations on the airfield. The MWD also has its own unique address for control and monitoring purposes. A MWD is used to detect movement within an established detection zone and communicate the status back to the Master.
<b>Control Panel</b>	This term is used to reference the device used to control and monitor the controllable stopbars and the associated lighting equipment. The control panel could be either an L-821 style pushbutton panel or a Touchscreen style control panel. The control panel is located in the Air Traffic Control Tower cab.
<b>SMGCS</b>	Acronym which means Surface Movement Guidance and Control System. SMGCS is an organized system created to improve and enhance low visibility operations.
<b>VSP</b>	Acronym for Variable System Parameter. This term relates to a time value (in seconds) determined by the airport that is used in conjunction with the Stopbar control timing. In the event that the automatic Stopbar control or MWDs fail, the Stopbars are reset after the VSP value has expired.



# TABLE OF CONTENTS

BRITE III Master Control Device ..... i

**a.0: Terms and Acronyms ..... III**

**1.0: Safety ..... 1**

1.1 :To use this equipment: ..... 1

    1.1.1 :Additional Reference Materials: ..... 1

    1.1.2 :Qualified Personnel ..... 1

    1.1.3 :Intended Use ..... 1

    1.1.4 :Storage ..... 1

        1.1.4.1 :Operation ..... 2

        1.1.4.2 :Material Handling Precautions ..... 2

        1.1.4.3 :Action in the Event of a System or Component Malfunction..... 2

        1.1.4.4 :Maintenance and Repair..... 2

        1.1.4.5 :Operation of Overloaded Regulators ..... 2

**2.0: BRITE III Master ..... 3**

2.1 :Manual Introduction ..... 3

    2.1.1 :How to work with the manual ..... 3

    2.1.2 :Record of changes ..... 3

    2.1.3 :Icons used in the manual ..... 3

2.2 :BRITE Master Introduction ..... 4

    2.2.1 :Compliance with Standards ..... 4

    2.2.2 :Uses ..... 4

    2.2.3 :Illustration ..... 4

    2.2.4 :Checking the Device ..... 5

        2.2.4.1 :Scope of Supply..... 5

        2.2.4.2 :Unpacking..... 5

        2.2.4.3 :Inspection ..... 5

    2.2.5 :Storage ..... 5

    2.2.6 :Views of the Device ..... 6

        2.2.6.1 :Front View with Control Unit ..... 6

        2.2.6.2 :Dimensions ..... 6

        2.2.6.3 :Weight..... 6

        2.2.6.4 :Rear View with Connections ..... 8

    2.2.7 :Construction ..... 9

        2.2.7.1 :Block Diagram ..... 9

        2.2.7.2 :Units..... 9

2.3 :Theory of Operation ..... 10

    2.3.0.1 :Architecture..... 10

2.4 :Installation of stand-alone BRITE Masters ..... 11

    2.4.1 :Installation in the Control Cabinet ..... 11

        2.4.1.1 :Power Supply..... 11

        2.4.1.2 :Connection to the Series Circuit ..... 11

    2.4.2 :Connection to the Ethernet Network ..... 12

    2.4.3 :Earth Grounding ..... 12

    2.4.4 :Safety Instructions ..... 13

2.5 :Replacing a stand-alone BRITE Master ..... 14

    2.5.1 :Replacement of Units ..... 14

        2.5.1.1 :Replacing a High-Voltage Unit..... 14

        2.5.1.2 :Replacing the Control Unit..... 15

2.6 :Troubleshooting and Fault Correction ..... 16

2.7 :Modes of Operation ..... 17

    2.7.1 :State on Delivery ..... 17

        2.7.1.1 :Base State ..... 17

Table of Contents

---

2.7.1.2 :Maintenance Mode.....	17
2.7.1.3 :Operating Mode .....	17
2.8 :Technical Specifications .....	18
2.8.1 :Environmental Conditions .....	18
2.8.1.1 :System Specifications.....	19
2.9 :Accessories and Spare Parts .....	20
2.9.1 :Ordering Code .....	20
Document Date (12/2010)	22

# 1.0 Safety

This section contains general safety instructions for installing and using ADB Airfield Solutions equipment. Some safety instructions may not apply to the equipment in this manual. Task- and equipment-specific warnings are included in other sections of this manual where appropriate.

## 1.1 To use this equipment:



### WARNING

Read installation instructions in their entirety before starting installation.

- Refer to the FAA Advisory Circular AC 150/5340-26, Maintenance of Airport Visual Aids Facilities, for instructions on safety precautions.
- Observe all safety regulations. To avoid injuries, always disconnect power before making any wiring connections or touching any parts. Refer to FAA Advisory Circular AC 150/5340-26.
- Become familiar with the general safety instructions in this section of the manual before installing, operating, maintaining or repairing this equipment.
- Read and carefully follow the instructions throughout this manual for performing specific tasks and working with specific equipment.
- Make this manual available to personnel installing, operating, maintaining or repairing this equipment.
- Follow all applicable safety procedures required by your company, industry standards and government or other regulatory agencies.
- Install all electrical connections to local code.
- Use only electrical wire of sufficient gauge and insulation to handle the rated current demand. All wiring must meet local codes.
- Route electrical wiring along a protected path. Make sure they will not be damaged by moving equipment.
- Protect components from damage, wear, and harsh environment conditions.
- Allow ample room for maintenance, panel accessibility, and cover removal.
- Protect components from damage, wear, and harsh environment conditions.
- Allow ample room for maintenance, panel accessibility, and cover removal.
- Protect equipment with safety devices as specified by applicable safety regulations.
- If safety devices must be removed for installation, install them immediately after the work is completed and check them for proper functioning prior to returning power to the circuit.

### 1.1.1 Additional Reference Materials:

- NFPA 70B, Electrical Equipment Maintenance.
- NFPA 70E, Electrical Safety Requirements for Employee Workplaces.
- ANSI/NFPA 79, Electrical Standards for Metalworking Machine Tools.
- OSHA 29 CFR, Part 1910, Occupational Health and Safety Standards.
- National and local electrical codes and standards.

### 1.1.2 Qualified Personnel

The term **qualified personnel** is defined here as individuals who thoroughly understand the equipment and its safe operation, maintenance and repair. Qualified personnel are physically capable of performing the required tasks, familiar with all relevant safety rules and regulations and have been trained to safely install, operate, maintain and repair the equipment. It is the responsibility of the company operating this equipment to ensure that its personnel meet these requirements.

Always use required personal protective equipment (PPE) and follow safe electrical work practices.

### 1.1.3 Intended Use



### WARNING

Using this equipment in ways other than described in this manual may result in personal injury, death or property and equipment damage. Use this equipment only as described in this manual.

ADB Airfield Solutions cannot be responsible for injuries or damages resulting from nonstandard, unintended applications of its equipment. This equipment is designed and intended only for the purpose described in this manual. Uses not described in this manual are considered unintended uses and may result in serious personal injury, death or property and equipment damage. Unintended uses may result from taking the following actions:

- Making changes to equipment that are not recommended or described in this manual or using parts that are not genuine ADB Airfield Solutions replacement parts.
- Failing to make sure that auxiliary equipment complies with approval-agency requirements, local codes and all applicable safety standards.
- Using materials or auxiliary equipment that are inappropriate or incompatible with ADB Airfield Solutions equipment.
- Allowing unqualified personnel to perform any task.

### 1.1.4 Storage



### CAUTION

If equipment is to be stored prior to installation, it must be protected from the weather and kept free of condensation and dust.

**Failure to follow this instruction can result in injury or equipment damage.**

1.1.4.1 Operation



**WARNING**

- Only qualified personnel, physically capable of operating the equipment and with no impairments in their judgment or reaction times, should operate this equipment.
- Read all system component manuals before operating this equipment. A thorough understanding of system components and their operation will help you operate the system safely and efficiently.
- Before starting this equipment, check all safety interlocks, fire-detection systems, and protective devices such as panels and covers. Make sure all devices are fully functional. Do not operate the system if these devices are not working properly. Do not deactivate or bypass automatic safety interlocks or locked-out electrical disconnects or pneumatic valves.
- Protect equipment with safety devices as specified by applicable safety regulations.
- If safety devices must be removed for installation, install them immediately after the work is completed and check them for proper functioning.
- Route electrical wiring along a protected path. Make sure they will not be damaged by moving equipment.
- Never operate equipment with a known malfunction.
- Do not attempt to operate or service electrical equipment if standing water is present.
- Use this equipment only in the environments for which it is rated. Do not operate this equipment in humid, flammable, or explosive environments unless it has been rated for safe operation in these environments.
- Never touch exposed electrical connections on equipment while the power is ON.

1.1.4.2 Material Handling Precautions



**CAUTION**

- This equipment may contain electrostatic sensitive devices.
- Protect from electrostatic discharge.
  - Electronic modules and components should be touched only when this is unavoidable e.g. soldering, replacement.
  - Before touching any component of the cabinet you should bring your body to the same potential as the cabinet by touching a conductive earth grounded part of the cabinet.
  - Electronic modules or components must not be brought in contact with highly insulating materials such as plastic sheets, synthetic fiber clothing. They must be laid down on conductive surfaces.
  - The tip of the soldering iron must be grounded.
  - Electronic modules and components must be stored and transported in conductive packing.

1.1.4.3 Action in the Event of a System or Component Malfunction



**WARNING**

- Do not operate a system that contains malfunctioning components. If a component malfunctions, turn the system OFF immediately.
- Disconnect and lock out electrical power.
- Allow only qualified personnel to make repairs. Repair or replace the malfunctioning component according to instructions provided in its manual.

1.1.4.4 Maintenance and Repair



**WARNING**

- Allow only qualified personnel to perform maintenance, troubleshooting, and repair tasks.
- Only persons who are properly trained and familiar with ADB Airfield Solutions equipment are permitted to service this equipment.
  - Disconnect and lock out electrical power.
  - Always use safety devices when working on this equipment.
  - Follow the recommended maintenance procedures in the product manuals.
  - Do not service or adjust any equipment unless another person trained in first aid and CPR is present.
  - Connect all disconnected equipment ground cables and wires after servicing equipment. Ground all conductive equipment.
  - Use only approved ADB Airfield Solutions replacement parts. Using unapproved parts or making unapproved modifications to equipment may void agency approvals and create safety hazards.
  - Check interlock systems periodically to ensure their effectiveness.
  - Do not attempt to service electrical equipment if standing water is present. Use caution when servicing electrical equipment in a high-humidity environment.
  - Use tools with insulated handles when working with electrical equipment.

1.1.4.5 Operation of Overloaded Regulators



**WARNING**

- Operation of a Regulator while overloaded at any step may result in equipment failure or equipment damage.



## 2.0 BRITE III Master

The BRITE III Master is a key subsystem in various Airfield Ground Lighting Automation Systems. ADB's BRITE III system is the latest state-of-the art individual airfield light control and monitoring system. BRITE III provides a radical leap in performance over prior airfield power line carrier systems. This system is designed to communicate on the existing airfield series circuit power line without requiring separate dedicated cabling. This system has patents pending in many countries around the world.

### Proprietary Information

General notice: other product names used here are for identification purposes only and may be trademarks of their respective companies.

AGLAST™ is a registered trademark of ADB and is known as BRITE III in the US market.

## 2.1 Manual Introduction

This document provides a manual on installation of Bi-Directional Series Transeiver (BRITE) Master.

In the following chapters, detailed information about commissioning, replacing and maintaining BRITE Master is presented.

### 2.1.1 How to work with the manual

1. Be familiar with the structure and content.
2. Carry out the actions completely and in the given sequence.



### 2.1.2 Record of changes

Page	Rev	Description	Checked	Approved	Date
All	4.1	New	Geert Bollens		23.12.09
	4.2	Updated safety information	Geert Bollens		22.04.10
	C	Updated all for US market	RH		4/6/11
	D	Intro and Install	JC	NH	8/12/11

### 2.1.3 Icons used in the manual

For all WARNING symbols see the Safety section.

Carefully read and observe all safety instructions in this manual, which alert you to safety hazards and conditions that may result in personal injury, death or property and equipment damage and are accompanied by the symbol shown below.

	<b>WARNING</b> • Failure to observe a warning may result in personal injury, death or equipment damage.
	<b>CAUTION</b> • Failure to observe a caution may result in equipment damage.

Manual Introduction

## 2.2 BRITE Master Introduction

The BRITE Master is available as a standard 4U 19" rack component, located above/close to the CCR (Constant Current Regulator), or as an integrated unit, built inside the CCR.

Maximum power rating is 30kVA at max. 6.6A RMS.

### 2.2.1 Compliance with Standards

FAA: Approved for use with SMGCS systems. This includes both Stop Bar and Runway Guard Light control/monitoring according to AC 150/5340-30 (Current Edition); manufactured to AC 120-57 (Current Edition).

ICAO: Complies with CAT I/II/III ICAO lamp supervision requirements. Supports A-SMGCS for enhanced aircraft guidance in all weather conditions to prevent aircraft collisions and runway incursions.

### 2.2.2 Uses

- BRITE III provides distributed intelligence in the airfield to control and monitor a variety of airfield lighting devices. It can be used in the following applications:
  - Stop bar control and monitoring
  - Elevated and in-pavement Runway Guard Light (RGL) control and monitoring
  - Interface with aircraft/vehicle presence sensors (option)
  - FAA Runway Status Light (RWSL) systems
  - As a key component in a Surface Movement Guidance Control System (SMGCS)
  - Failed-lamp detection and location identification
  - Selective control and monitoring of various airfield lighting devices
- BRITE III provides relevant information concerning the status of various airfield lighting devices to both maintenance and airport control tower personnel.
- The BRITE III can also be used to:
  - Support optimization of traffic volume, flexibility, and air side safety.
  - Meet stringent command timing requirements while ensuring elimination of interference on FAA RWSL applications.
  - Ensure reliable Stop Bar guidance for aircraft on the ground during CAT III conditions, increasing safety and reducing the risk of runway incursions.
  - Automatically detects and reports lamp failure location, decreasing downtime and maintenance costs.

### 2.2.3 Illustration

Figure 1: BRITE Master front view

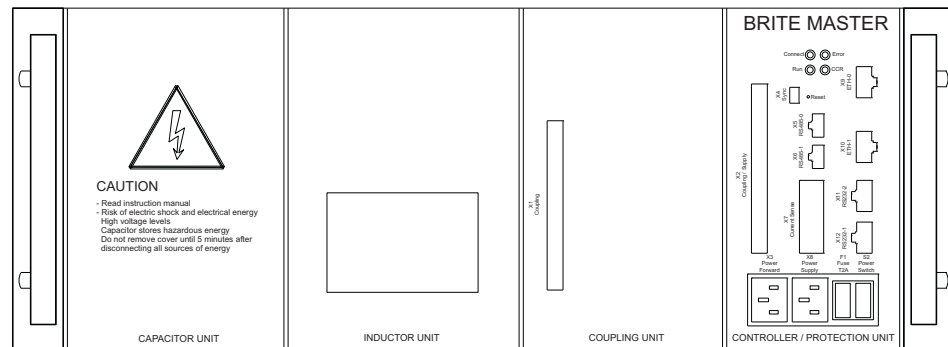

## 2.2.4 Checking the Device

### 2.2.4.1 Scope of Supply

44A6898 BRITE Master is supplied with four 19" (0.5m) long cord-set cables for connection to the high-voltage lines from the series circuits, and includes an instruction manual.

### 2.2.4.2 Unpacking

The device has been fully assembled, tested and packed at the factory and has no internal transport locks.

**NOTE:** In case of significant differences in temperature between the means of transport and the place where the device is to be unpacked, it is recommended to leave the device in its packaging for acclimatization, in order to avoid damage from condensation. (e.g. 12 hours for a 30°F (20°C) temperature difference, longer with greater differences.)

### 2.2.4.3 Inspection

The delivery must be checked to make sure that it is complete and in perfect condition. The supplier must be notified of any complaints within 2 weeks. After this period, complaints about the delivery will not be accepted. In the event of the goods being returned, the same transport packaging must be used. The number on the nameplate must be checked against the order number on the delivery note. The nameplate, Figure 2 is located on the back of the device (example: BRITE Master 30kVA).

**Figure 2: Nameplate of the BRITE Master**

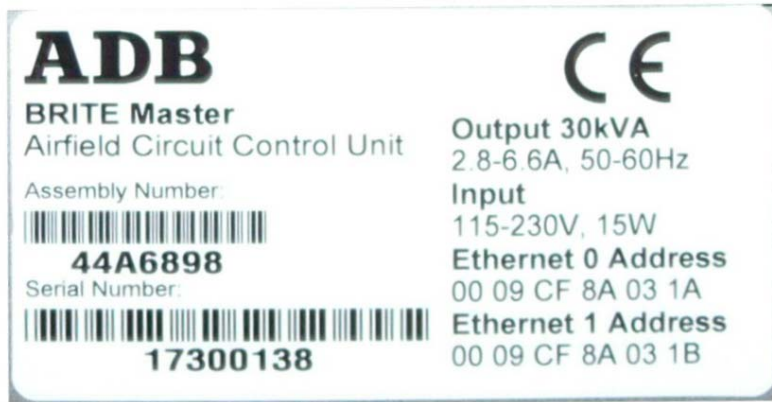

The address (MAC ID) of the Ethernet interface *Eth0* and *Eth1* (e.g. *Eth1* Address 0009CF8A 01D9, see illustration) should be recorded and will be utilized during commissioning.

## 2.2.5 Storage

If the BRITE Master has to be stored for a longer period between receipt and installation, it is recommended to leave the device in its transport packaging.

If the BRITE Master has to be stored without its packaging, it must be stored in a clean, dry location in order to prevent contamination via the ventilation slots in the top cover plate. The storage temperature is shown in "Technical Specifications" on page 18.

**NOTE:** Allow the BRITE Master to acclimatize prior to installation for 12 hours before switching on power and the high voltage in the series circuit.

2.2.6 Views of the Device

2.2.6.1 Front View with Control Unit

Figure 3: Front view with Control Unit of the BRITE Master

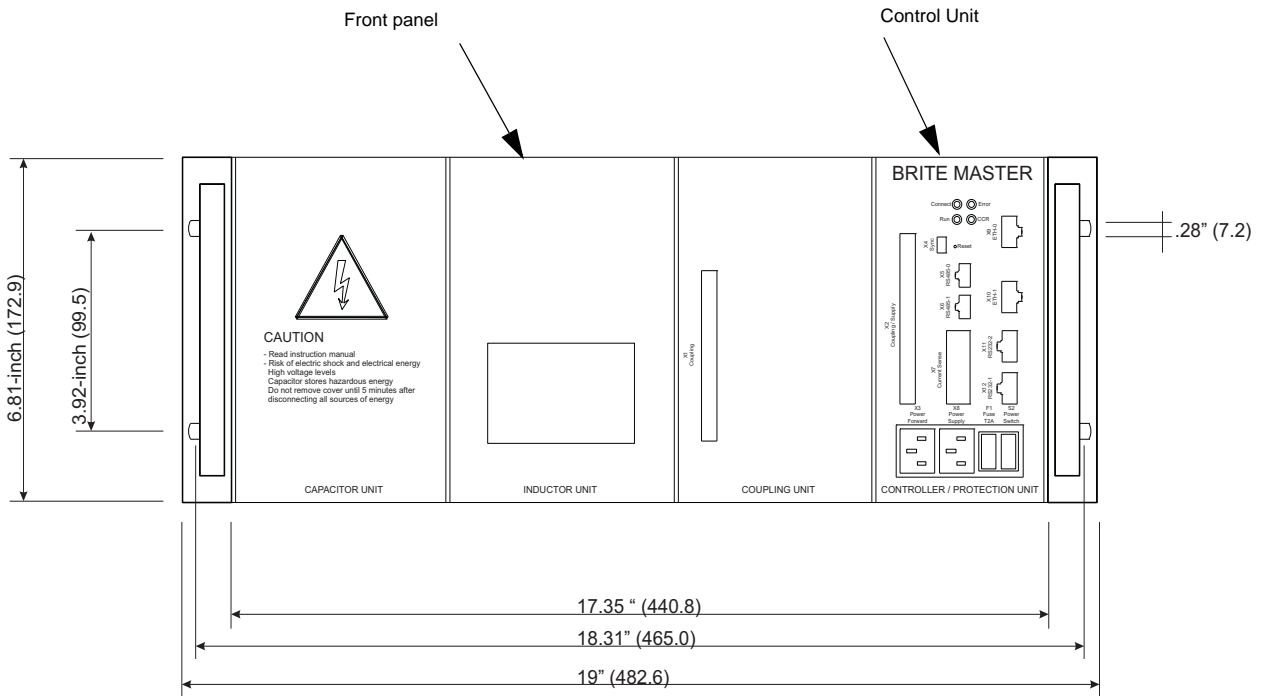

The high-voltage units for the series circuit can be found behind the front panel (from left to right):

1. Capacitor Unit
2. Inductor Unit
3. Coupling Unit
4. Controller/Protection

2.2.6.2 Dimensions

Dimensions: 19 x 17.72 x 5 in (W x D x H) 483 x 450 x 127 mm

2.2.6.3 Weight

Master: 55.14 lbs (25 kg)

Figure 4: Front panel of the Control Unit of the BRITE Master 20kVA

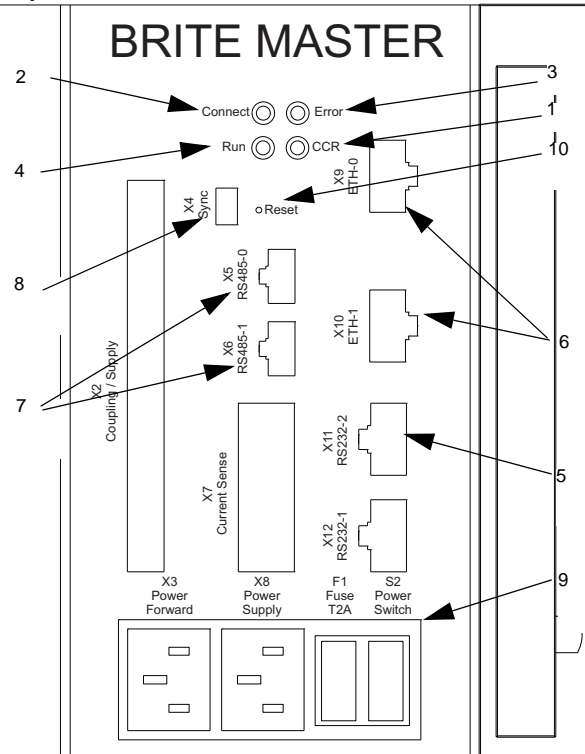

The Control Unit's individual operation and display elements have the following functions:

1. *CCR* LED yellow
  - Constant current regulator is switched on.
  - Blink (together with the 3 other LED's): Master is in delivery state (no network IP address configured)
2. *Cmd* LED green
  - Communication to BRITE PC is in place
  - Blink: BRITE Master is in maintenance mode (configuring BRITE remotes)
3. *Error* LED red
  - System fault
  - Blink: Synchronization error between the synchronized BRITE Masters
4. *Run* LED green
  - System is running
  - Blink: Master is not configured
5. *X11 Service* 10-pin RJ connector
  - RS232 system service connector
  - Details in Installation Manual BRITE Software
  - During normal operation it is not used
6. *X9-10 Eth* RJ-45 interface
  - 100Mbit TCP/IP network interface
  - For communication with BRITE PC via a hub or switch. The user can determine the IP address that must be assigned to this connection (software function).
  - The address (MAC ID) of the interfaces are to be found on the nameplate of the BRITE Master.
7. *X5-6 RS485* Bus interfaces
  - For future use

8. X4 Sync connector
  - For verifying the master synchronization
  - Not used for normal operation
9. X3, X8, F1, S2 Main Power connections
  - Main power connections 110 – 230Vac 50/60 Hz
  - X8: To main power outlet
  - F1: T2 fuse
  - S2: Main power switch
  - X3: Power forward for Master electronics
10. Reset
  - This button resets BRITE Master to the delivery condition (FLASH pages including the current configuration, logs and IP addresses are deleted).
  - The button is recessed, so for activation, a pointed tool (like a pen tip) has to be used.
  - All network cables to the BRITE Master must be disconnected (No open TCP/IP connections may exist) if the Master has to be set to delivery condition by using the reset button, otherwise pushing the button will be ignored.
  - Reset has to be pushed at least 10 seconds. If condition is fulfilled all LEDs will go to the ON state.
  - A restart of the system must be done manually (after restart all LEDs begin to blink; factory default condition has been restored).

2.2.6.4 Rear View with Connections

Figure 5: Rear view of the BRITE Master 20kVA

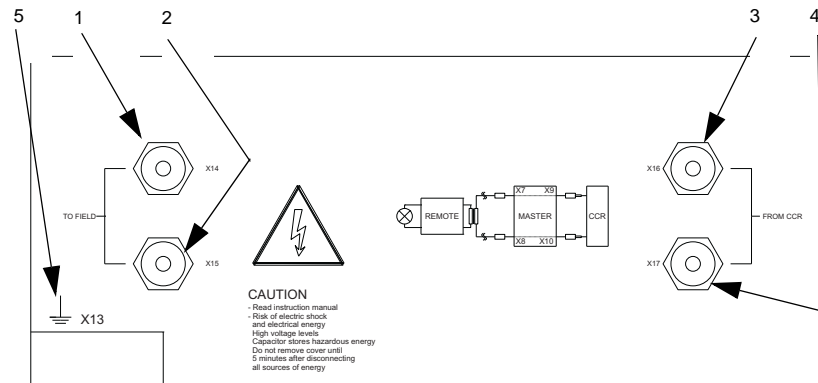

- 1 X14 Cable with connection **socket** to series circuit
- 2 X15 Cable with connection **socket** to series circuit
- 3 X16 Cable with connection **plug** to Constant current regulator or Filter
- 4 X17 Cable with connection **plug** to Constant current regulator or Filter
- 5 X13 Screw for earth ground connection

## 2.2.7 Construction

The BRITE Master consists of several replaceable units, described in the following subsections.

### 2.2.7.1 Block Diagram

**Figure 6: Block diagram of the BRITE Master**

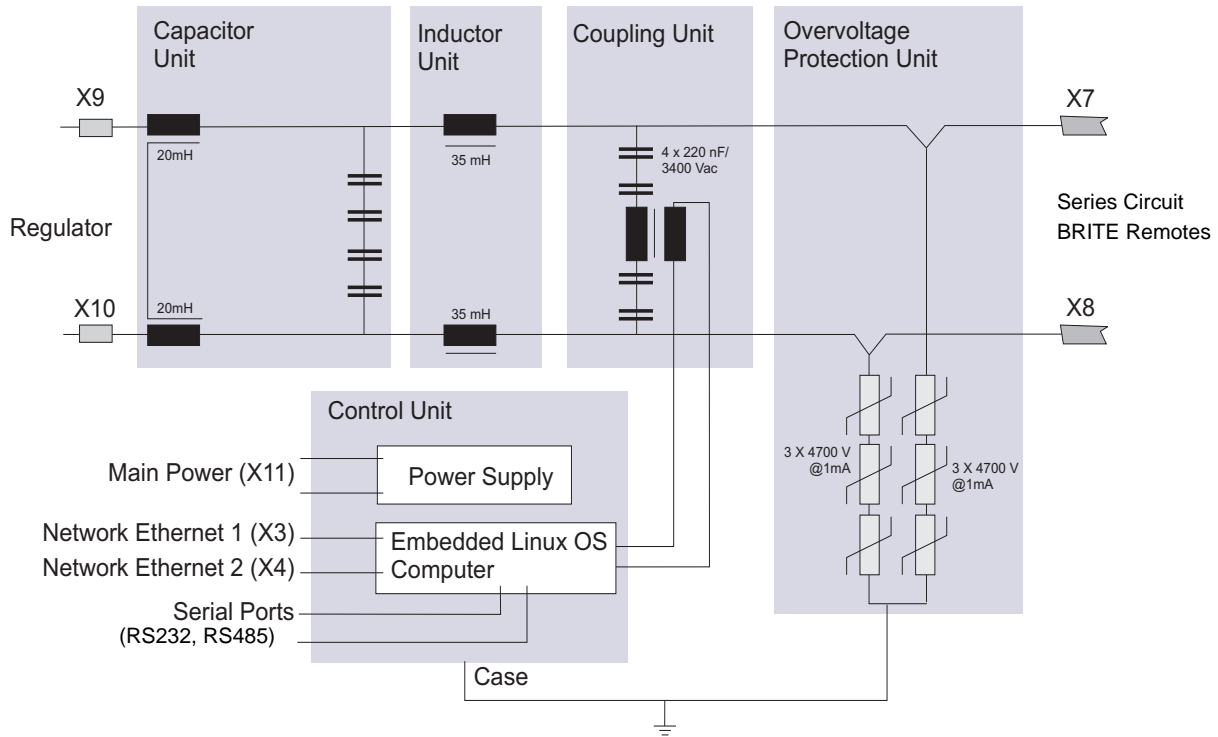

### 2.2.7.2 Units

#### Capacitor Unit

- Filter unit, consisting of a current-compensated choke and a capacitor connected in parallel. These components suppress high-frequency interferences caused by the SCR switching of the Constant current regulator.

#### Inductor Unit

- Filter unit, consisting of two coils connected in series to the series circuit. It serves to suppress high-frequency interferences caused by the SCR switching of the Constant Current Regulator.

#### Overvoltage Protection Unit

- Lightning protection unit, protecting the BRITE Master from high voltages in the series circuit that would be injected as a result of a lightning strike.

#### Coupling Unit

- Component assembly, consisting of transmission coils and capacitors. It serves to couple and/or uncouple the communications signal to the series circuit.

#### Control Unit

- Control unit with built-in power supply. It enables data exchange with the BRITE PC via Ethernet and controls communication to the BRITE Remotes via the series circuit.

## 2.3 Theory of Operation

Background Information: BRITE uses power line carrier (PLC) technology to communicate between controlling units on an airfield lighting series circuit. A BRITE system typically consists of one high voltage modem, or Master, collocated with the Constant Current Regulator (CCR) powering the airfield lighting circuit and many slave units, or Remotes, collocated with individual lights in the field. A typical BRITE topology is provided in Figure 7.

**Figure 7: Typical BRITE Topology**

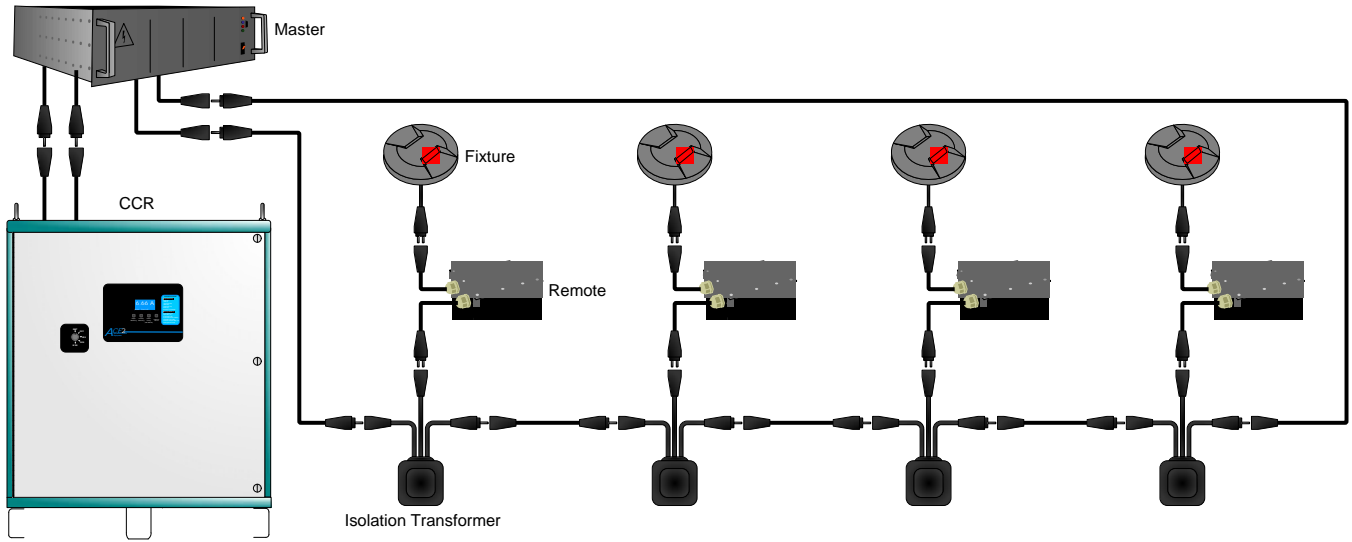

Theory of Operation

### 2.3.0.1 Architecture

Figure 8 depicts the general nature of the system components and their interactions. The "Control System", shown in grey, is an external ALCMS system that provides controlling commands and digests Master and Fixture status reports. There is typically only one control system in the architecture. The "Master", shown in blue, is the high voltage modem that communicates commands to and receives status from the fixtures. There can be many masters in a given system. Masters digest commands from the control system and provide status to it. Masters also communicate amongst themselves to maintain communication timing synchronization. Each master communicates with the fixtures on its respective circuit.

**Figure 8: Series Circuit Master / Fixture Architecture**

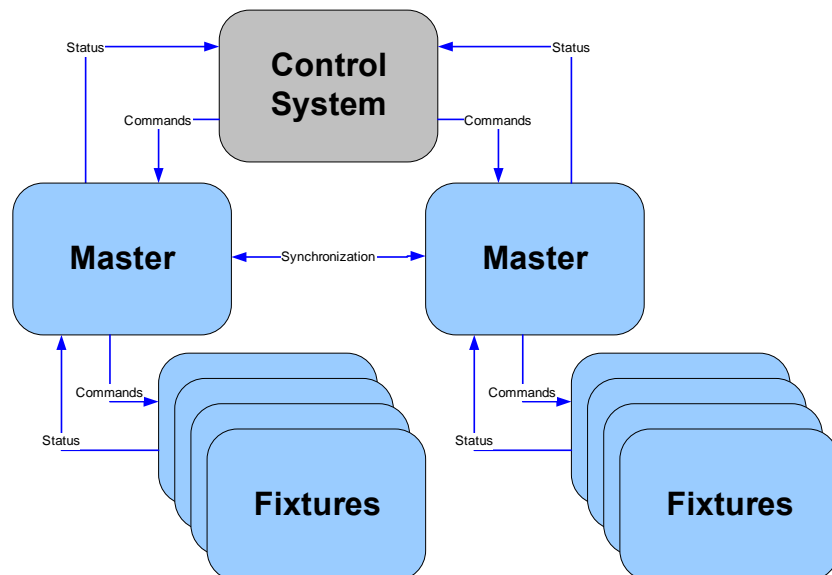



## 2.4 Installation of stand-alone BRITE Masters

### 2.4.1 Installation in the Control Cabinet

**NOTE:** The BRITE Master is designed for protection class IP 20 (NEMA 1) according to IEC 529 and is approved for contamination grade 1 according to IEC 60 664-1 (operation in dry air-conditioned spaces).

The environmental conditions are defined in “Environmental Conditions” on page 18.

When installing several BRITE Masters in the same control cabinet, there must be a minimum distance of 4” (100mm) between adjacent units.

There must be a minimum of 2” (50mm) free space underneath the lowest unit.

There must be a minimum of 2” (50mm) free space above the topmost unit.

The devices should be mounted on rails, brackets or tilting racks. They are to be fixed with the 4 clamp bolts positioned on the front.

The ground cables of the BRITE Masters must be connected to the bus bar in the electrical cabinet.

The control cabinet bus bar must be connected by a wire with a minimum cross-sectional area of AWG 0 (50mm<sup>2</sup>) to the central earth ground in the control room.

#### 2.4.1.1 Power Supply

The power cable (18 AWG (0.75mm<sup>2</sup>) recommended) is to be provided by the user. The plug supplied is to be attached to the cable. The cable is used to connect the mains socket *X/F11 Power* at the rear of the BRITE Master to the cabinet power supply.

Each BRITE Master must be individually fused with a 10 A circuit breaker.

(For the location of the power socket, refer to “Rear View with Connections” on page 8).

#### 2.4.1.2 Connection to the Series Circuit

The high-voltage connections *X14*, *X15*, *X16* and *X17* on the BRITE Master are each pre-prepared with cables with a length of 19-in (0.5m), in accordance with the FAA L-824 specification.

The plugs on the built-in cables *X16* and *X17* are connected to the sockets on the extension cables going to the CCR. The latter have to be separated in the middle beforehand. The extension cables must be shortened to the appropriate length and mounted on the cabinet terminal strip. From there the connection to the Constant current regulator is made.

The connections from the control cabinet to the Constant current regulator are to be established on site.

The sockets on the built-in cables *X14* and *X15* are connected with the plugs on the extension cables. The free ends of these extension cables are to be shortened to the appropriate length and mounted on the cabinet terminal strip. From there the connection is established to the series circuit cables, which lead to the airfield.

(For the location of the series circuit connectors: refer to “Rear View with Connections” on page 8, *X14*, *X15*, *X16* and *X17*).

## 2.4.2 Connection to the Ethernet Network

Figure 9: Ethernet connections

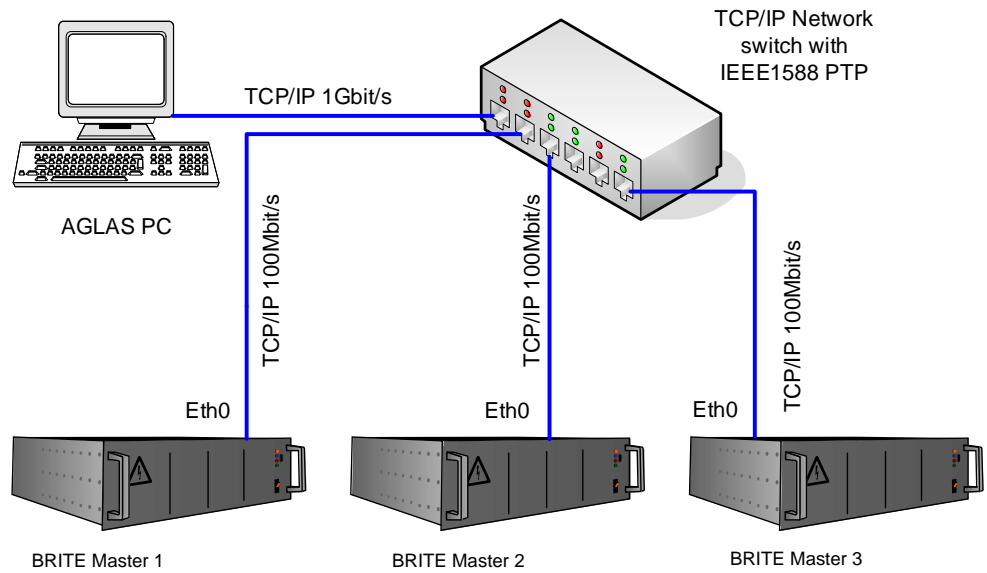

The BRITE Master is to be connected via a shielded CAT5 network cable, with RJ45 plugs to the rear connector X9 *Ethernet 0* and the hub or switch of the Ethernet network. The cable is to be run as a 1:1 connection.

The usual segment length restrictions for Ethernet networks apply.

(For the location of the Ethernet connectors: refer to “Front View with Control Unit” on page 6).

## 2.4.3 Earth Grounding

To protect the devices against surges that could be caused by a lightning strike, each BRITE Master is to be earth ground separately via the earth ground screw, with minimum induction or resistance. For this an earth ground cable with a suitable cable lug is to be fixed to the earth ground screw on the BRITE Master (M6 screw thread). The cross-sectional area of the cable should be at least AWG 8 (6mm<sup>2</sup>) with a maximum cable length of 39” (1m).

All masters ground terminals must be connected to a common earth grounded bar in the vault or substation.

(For the location of the earth ground screw: refer to “Rear View with Connections” on page 8, X13).

## 2.4.4 Safety Instructions



### DANGER

Work on the incoming power supply systems or the series circuit must only be carried out by trained, qualified staff.  
Follow the currently applicable regulations according to local and international standards.

**NOTE:** The BRITE Master is maintenance free.  
The BRITE Master may only be opened by authorized maintenance personnel.



### WARNING

When working on or carrying out measurements on the device, the following basic rules must be followed:

- The device must be disconnected from the incoming power supply (isolated).
- The device must be secured against being accidentally switched on.
- Disconnection must be measured or checked.

The housing must not be opened until all electrical supply cables have been disconnected for at least 5 minutes. When the housing is open, the incoming power and the high voltage on the series circuit are exposed and freely accessible at various locations. For this reason, work or measurements on the component assemblies are only permitted when there is a second person in the room who will be able to take appropriate action in the event of an accident.

Only potential-free instruments may be used for measurements on componentry.

- Components still carry hazardous or deadly voltages even after being switched off.
- ESD susceptible devices (ESDS): Components susceptible to damage by electrostatic discharges
- The component assemblies contain components that are susceptible to electrostatic discharges. These components can be very easily destroyed if not handled properly. However, if it is necessary to work on electronic assemblies, follow the instructions below:
- Electronic assemblies should only be touched if working on them is absolutely necessary.
- If assemblies have to be touched, the bodies of those working on them must be discharged to ground immediately prior to contact.
- Connection pins and printed circuit conductors must not be touched. Assemblies must only be held by the edge.
- Assemblies may not be brought into contact with highly insulating materials – e.g. plastic parts, insulating table tops, or clothing made of artificial fibers.
- Assemblies may only be placed on conductive surfaces.
- Assemblies and components must only be stored or shipped in conductive packaging (such as metallic or metallized plastic containers).
- If the packaging itself is not conductive, assemblies must be wrapped in a conductive material before packing.

## 2.5 Replacing a stand-alone BRITE Master

Step 1: Before exchanging a BRITE Master, record its technical information.

Step 2: Switch off the BRITE Master to be replaced with *S2 Power Switch* and its associated series circuit and disconnect it from the mains power supply by removing the fuses of the Constant current regulator.

Step 3: Pull out the cut-out for the series circuit, if available. If possible earth ground the series circuit and wait 5 minutes until the circuit is fully discharged.

Switch off any ground fault detection devices (IRMS) which may be connected to this circuit.

**NOTE:** For all work on the devices, follow the “Safety Instructions” on page 13.

Step 4: Removing the BRITE Master

First separate the high-voltage connections *X14*, *X15*, *X16* and *X17* on the BRITE Master at their cable plug connections and pull the rubber connector out of the *X6 Power* socket.

Open the ground connection by loosening the nut on the earth ground screw *X13* of the BRITE Master.

Remove connected network links on *X9 Ethernet 0*, and *X10 Ethernet 1*.

Now, physically remove the BRITE Master from the control cabinet.

Step 5: Install the new BRITE Master according to the “Installation of stand-alone BRITE Masters” on page 11 and turn over the recorded technical information to the **commissioning engineer**. The commissioning engineer is generally provided by ADB.

Step 6: Introduce the new Ethernet MAC addresses (2) into the respective BRITE PC Master configuration file.

Load the respective BRITE Master configuration file into the BRITE Configuration tool, prepare the Network IP address and start the BRITE Master in maintenance mode as described in: “96A0430 BRITE Configuration Software - User Manual ”

### 2.5.1 Replacement of Units

Replacing a complete BRITE master unit is not recommended unless a definite fault pattern can be discerned (see “Troubleshooting and Fault Correction” on page 16).

#### 2.5.1.1 Replacing a High-Voltage Unit

The corresponding order number of the required unit can be found in the spare parts list at the end of this chapter.

The high-voltage equipment comprises the Capacitor Unit, the Inductor Unit, the Coupling Unit and the Controller/Overvoltage Protection Unit. To replace these units:

1. Switch off the BRITE Master and its associated series circuit.
2. Remove the long front panel on the BRITE Master by unscrewing the 6 neck collar screws.
3. Pull out the unit to be replaced from the BRITE Master and push the new unit into the guides, until the connection plugs lock into place.
4. Replace the front panel and tighten the screws.

### 2.5.1.2 Replacing the Control Unit

The order number of the unit can be found in the spare parts list at the end of this chapter. ***The order number only refers to the printed-circuit board, the front panel is not included in a replacement part delivery.***

Switch off the BRITE Master and its associated series circuit, pull the rubber connector from the socket *X6 Power Supply*, and disconnect the network connections of the BRITE Master. Furthermore, disconnect all connectors between controller unit and coupling unit.

**NOTE:** Follow of the instructions regarding components susceptible to electrostatic discharges referred to in "Safety Instructions" on page 13.

- Slightly lift the front panel of the Control Unit by loosening the 4 neck collar screws.
- Then: pull out the Control Unit circuit boards that need to be replaced.
- Loosen the 2 screws at *X7 current sense* connector and remove the front plate from the circuit boards.
- Screw the frontplate on the new circuit boards (*X7 current sense* connector) push the new circuit board into the guides, and reconnect all connectors.
- Now tighten the 4 screws of the front panel.

## 2.6 Troubleshooting and Fault Correction

Based on the fault pattern (see table), identify and remove the unit in question from the BRITE Master, check and in case of malfunction, replace it with a new one in accordance with the information in Table 1.

The fault correction is described in so far as it applies to the BRITE Master.

**Table 1: BRITE Master: Fault patterns, fault location and fault correction**

Fault pattern	Fault location	Fault correction
Long reaction times or no reaction of the Remotes to power-line communication in the series circuit	Visually inspect the Capacitor Unit for scorch marks, blisters or sooty deposits.	Replace the Capacitor Unit and the Coupling Unit with new ones.
	Visually inspect the Inductor Unit for scorch marks, blisters or sooty deposits.	Replace the Inductor Unit with a new one.
Constant current regulator shuts down the series circuit. Cause may be a short circuit in the series circuit.	Visually inspect the Capacitor Unit, the Coupling Unit and the Overvoltage Protection Unit for scorch marks, blisters or sooty deposits. Test as to whether there is a short circuit between the two high-voltage cables: <i>X14-X15</i> and <i>X16-X17</i> .	Replace the Capacitor Unit and the Overvoltage Protection Unit. Remove Capacitor Unit and Coupling Unit one after another until the short circuit disappears. Change the unit causing the short circuit.
Constant current regulator shuts down the series circuit. Cause may be a break in the series circuit.	Visually inspect the Inductor Unit for scorch marks, blisters or sooty deposits. Carry out a continuity test on the high-voltage connections in the Master between the plug and socket: <i>X14-X15</i> and <i>X16-X17</i> .	Replace the Inductor Unit with a new one.
Function display does not work	Check fuse <i>F1</i> .	Replace the fuse. Replace the Control Unit.

Troubleshooting and Fault Correction

## 2.7 Modes of Operation

### 2.7.1 State on Delivery

More information about the modes of operation can be found in “96A0430 BRITE Configuration Software - User Manual”.

The BRITE Master is delivered with no default IP address set for either Ethernet interfaces *Eth0 (X9 Eth 0)* and *Eth1 (X10 Eth 1)*. The address must be entered by the user via the BRITE PC (software function).

Furthermore no BRITE Remotes have been logged on, that is to say the internal Remote table is empty.

About 1 minute after powering up the BRITE master, 4 LED's will be blinking simultaneously on the front panel.

#### 2.7.1.1 Base State

After assigning the IP address (software function), the user can communicate via the BRITE PC with the BRITE Master. This is indicated by one blinking and one steady lit green LED.

The BRITE Master is now in the base state (IP address known, internal Remote table empty). Only then the BRITE Master is able to accept configuration parameters from the BRITE PC.

#### 2.7.1.2 Maintenance Mode

The BRITE Master only changes to maintenance mode if it gets a command from user via the TCP/IP maintenance port and additionally the maintenance level, BRITE Master never goes to maintenance mode by its own, even if it has no valid configuration). The maintenance mode is used for configuration or system checks and is indicated by 2 blinking green LED's.

During maintenance mode the communication on other TCP/IP ports is locked, switch commands (blocks, Remotes,...) are not possible.

When exiting maintenance mode a choice for validation of the BRITE Master's configuration has to be done. One of three following options is possible:

- *Configuration invalid:* Normal BRITE operation is not possible. This has to be chosen if the BRITE System still is too unstable for normal operation.
- *Configuration preliminary:* For preliminary operation with an BRITE system although configuration is still not complete or system runs not completely stable.
- Configuration valid:
  - Sets current configuration ready for normal operation after validation via consistency check.
  - A message for ending the maintenance mode is sent to all open connections.

#### 2.7.1.3 Operating Mode

After completion of parameter setting, the BRITE Master switches to normal operating mode. In this mode, all BRITE Remotes are polled in a cycle to query their status. Now unrestricted functionalities for communication with the BRITE Remote and switching of the lights are available for the user.

In operating mode, the BRITE Master monitors the communication connection to the BRITE PC. If the BRITE Master does not receive a telegram from the BRITE PC within a predefined time period (configured in the configuration file), it sends a failsafe telegram to its Remotes, which then switch the connected lighting fixtures to the predefined failsafe status. This status is maintained until the connection between BRITE PC and BRITE Master is operational again and a new switch command is transmitted.

## 2.8 Technical Specifications

### 2.8.1 Environmental Conditions

#### Operating Temperature:

- Remote: -67°F to +149°F (-55°C to +65°C)
- Master: -4°F to +131°F (-20°C to +55°C)

#### Storage Temperature:

- Remote: -67°F to +167°F (-55°C to +75°C)
- Master: -40°F to +131°F (-40°C to +55°C)

#### Altitude:

- 0 - 6,600 feet (2 km) above sea level

#### Humidity:

- Remote: 0 - 100%
- Master: 10-90% (non-condensing)

#### Enclosure Protection Level:

- Remote: IP 68 (NEMA 6P)
- Master: IP 20 (NEMA 1)

#### EMC (CE Approved):

- Compliant to EN 50081-2 (EMC emission standard)
- Compliant to EN 50082-2 (EMC immunity standard)
- Compliant to 60950 (IT equipment standard)

#### Lightning Protection:

- BRITE III system is designed to exceed the lightning test requirements defined in FAA AC 150/5345-10 (Current Edition). Specification: 10 by 20 microsecond current surge of 15kA with the subsequent power-follow current and a voltage surge of 10kV per microsecond.



2.8.1.1 System Specifications

BRITE Master Input Voltage:	110-230V AC, 50/60Hz ( $\pm 7\%$ )
BRITE Master Input Power:	15W
Series circuit operating voltage:	Max. 5000V AC
Series circuit peak voltage:	Max. 15kV
Transmit Frequency:	8 different frequency bands between 20kHz and 150kHz
Maximum switching power:	6.6A/360VA for each remote
Power line current:	1.9 up to 6.93A RMS
LAN connection to redundant network interface:	IEEE 802.3 100 BaseT
Dielectric strength rating:	
	-Remote: 1500V DC
	-Master: 23kV DC
Remote Power Up Mode:	ON; OFF; Flashing (BLINK); last commanded state (maintained)
Remote Fail-Safe Mode:	ON; OFF; Flashing (BLINK); last commanded state (maintained)
Number of controlled and monitored lamps per unit:	
	-Remote: 1 or 2
	-Master: Up to 300 Remotes
Data transmission rate power line:	
	-Remote: Up to 40 kB/s
	-Master: Up to 40 kB/s
BRITE Remote Power Consumption:	22VA
Controlled lamps per system:	10,000
Maximum roundtrip series circuit length:	Up to 9.3 miles (15Km)
Lamp failure reaction:	Short is placed across isolation transformer as soon as lamp filament failure detected
Operation State after Power-Off:	Remote does not reset and remains in operation, if circuit power loss <2 sec.
Mean-Time-Between Failure:	
	-Master: 100,000 hours
	-Remote: 150,000 hours

## 2.9 Accessories and Spare Parts

**Table 2: Accessories and Spare Parts**

Part	ADB Order number
Master Capacitor Unit	AG2 20101
Master Inductor Unit	AG2 20102
Master Coupling Unit	AG2 20103
Master Overvoltage Protection Unit	AG2 20104
Master Controller Unit	AG2 2000

### 2.9.1 Ordering Code

BRITE III Master 44A6898 for use on up to 30KW CCR, 19-inch Rack Mount



**BRITE III Master Control Device  
Installation Manual**

**Registered office:**

ADB Airfield Solutions LLC  
977 Gahanna Parkway  
Columbus, OH 43230  
USA  
Phone: +1 (614) 8611 304  
Fax: +1 (614) 8642 069

France  
Phone: +33 (1) 4922 9250  
Fax: +33 (1) 4922 9255  
  
ADB Airfield Solutions GmbH & Co. KG  
Von-der-Tannstr. 31  
90439 Nürnberg  
Germany  
Phone: +49 (911) 9239 1287  
Fax: +49 (911) 2852 582

ADB  
Unit 44, Business Innovation Centre  
Binley Business Park  
Harry Weston Road  
Coventry, CV3 2TX  
United Kingdom  
Phone: +44 (0)1455 883130  
Fax: +44 (0)1455 883179

**Other addresses:**

ADB Airfield Solutions Ltd.  
5500 North Service Road, Suite 1108  
Burlington, Ontario L7L 6W6  
Canada  
Phone: +1 (905) 331 6887  
Fax: +1 (905) 331 9389

ADB N.V.  
Asia Pacific Regional HQ  
Unit C-9.3.1, Level 9, Block C  
Mines Waterfront Business Park  
No. 3, Jalan Tasik  
The Mines Resort City  
43300 Seri Kembangan Selangor  
Malaysia  
Phone: +603 8941 4868  
Fax: +603 8942 4869

ADB  
Airfield Solutions  
Leuvensesteenweg 585  
B-1930 Zaventem  
Belgium  
Phone: +32 (2) 722 17 11  
Fax: +32 (2) 722 17 64  
info.adb@adb-air.com  
www.adb-air.com

ADB Airfield Technologies Ltd.  
01A Unit, 9F, LSH Plaza  
8, Wangjing Jie  
Chaoyang District  
Beijing 100102  
P.R. China  
Phone: +86 10 8476 0106  
Fax: +86 10 8476 0090

ADB Airfield Solutions Netherlands  
Prinses Beatrixlaan 614  
Office D3.14  
2595 BM Den Haag  
The Netherlands  
Phone: +31 (0)70 304 3611  
Fax: +31 (0)70 333 8094

ADB N.V.  
Dubai Silicon Oasis  
Wing D - Office D-309  
P.O. Box 341218  
United Arab Emirates  
Phone: + 971 4372 4970  
Fax: + 971 4372 4975

ADB Airfield Solutions, Ltd.  
2nd Floor, 3 Rivonia Village  
Cnr Mutual Road and Rivonia Boulevard  
South  
Rivonia 2128  
South Africa  
Phone: +27 (11)234 6768  
Fax: +27 (11)234 6739

ADB N.V./S.A.  
39/47 Boulevard Ornano  
93200 Saint-Denis

**ADB Airfield  
Solutions USA**

977 Gahanna Pkwy  
Columbus, Ohio 43230 USA  
Telephone: (+1 614-861-1304)  
Fax: +1 614-864-2069  
www.adb-airfieldsolutions.com

The information contained in this document is subject to change without notice. ADB reserves the right to make changes and improvements to its products and assumes no responsibility for making these modifications on any equipment previously sold.

96A0428 © 2010 ADB Airfield Solutions All Rights Reserved

**Document Date (12/2010)**